

DT 4.10
DT 4.16

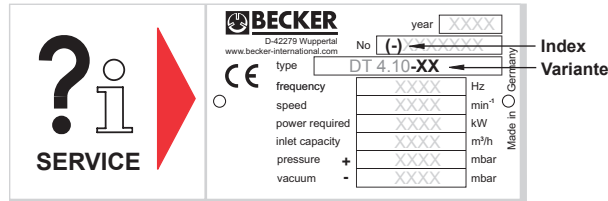
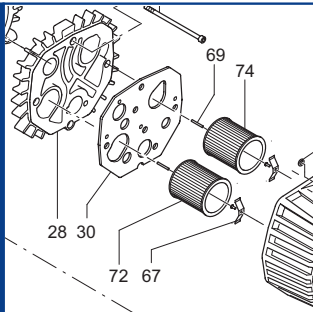

Ersatzteilliste
Spare parts list
Liste de pièces de rechange
Listino pezzi di ricambio
Lista de piezas de recambio
Lista de peças sobresselentes
Reserveonderdelenlijst
Atsarginių dalių sąrašas
Varuosad nimekirja
Rezerves daļu saraksts

Reservedelsliste
Reservdelslista
Varaosuettelo
Reservedelsliste
Wykaz części zamiennych
Tartalékalkatrész lista
Seznam náhradních dílů
Seznam nadomestnih delov
Zoznam náhradných dielov
Rezervni dijelovi popis

Lista pieselor de schimb
Páirteanna spártha liosta
Κατάλογος ανταλλακτικών
Yedek parça listesi
Списък на резервните части
Перечень запасных частей
スペアパーツリスト
예비 부품 목록
备用零件目录

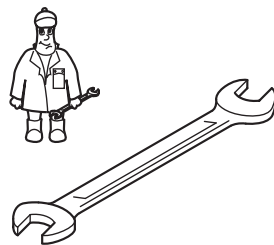

Wartung
Maintenance
Entretien
Manutenzione
Mantenimiento



Pos.	Menge ²⁾ Quantity Quantité Quantità Cantidad	Bestell-Nr. Ident No. No. Identification No. Identificazione No. de pedido	Bezeichnung Description Designation Designazione Descripción
DT 4.10			
24	SATZ/KIT	901327 00007	Schieber, Rotor Vane, Palette, Empujador
72	1	909518 00000	Filterpatrone, Filter cartridge, Cartouche Filtrante, Cartuccia filtro, Cartucho de filtro
74	1	909554 00000	Filterpatrone, Filter cartridge, Cartouche Filtrante, Cartuccia filtro, Cartucho de filtro
DT 4.16			
24	SATZ/KIT	901347 00007	Schieber, Rotor Vane, Palette, Empujador
24		901375 00007	" (DT 4.16/05-51)
72	1	909519 00000	Filterpatrone, Filter cartridge, Cartouche Filtrante, Cartuccia filtro, Cartucho de filtro
74	1	909542 00000	Filterpatrone, Filter cartridge, Cartouche Filtrante, Cartuccia filtro, Cartucho de filtro

²⁾ erforderliche Bestellmenge / necessary order quantity / quantité nécessaire / quantità di ordinazione necessari / cantidad necesario

DT 4.10
 DT 4.16

Standard



Variante



DT 4.10/XX

- ①
 1~ Einphasenwechselstrom
 1~ single-phase AC
 1~ AC monofasé
 1~ AC monofase
 1~ AC monofásica

DT 4.16/XX

- ②
 1~ Einphasenwechselstrom
 1~ single-phase AC
 1~ AC monofasé
 1~ AC monofase
 1~ AC monofásica

③+④
 /05-51 (1~/3~)

- ⑤
 K/0-06
 mit Kühler - ohne Filterung
 with cooler - without filter
 avec refroidisseur - sans filtre
 con raffreddatore - senza filtro
 con refrigerador - sin filtro

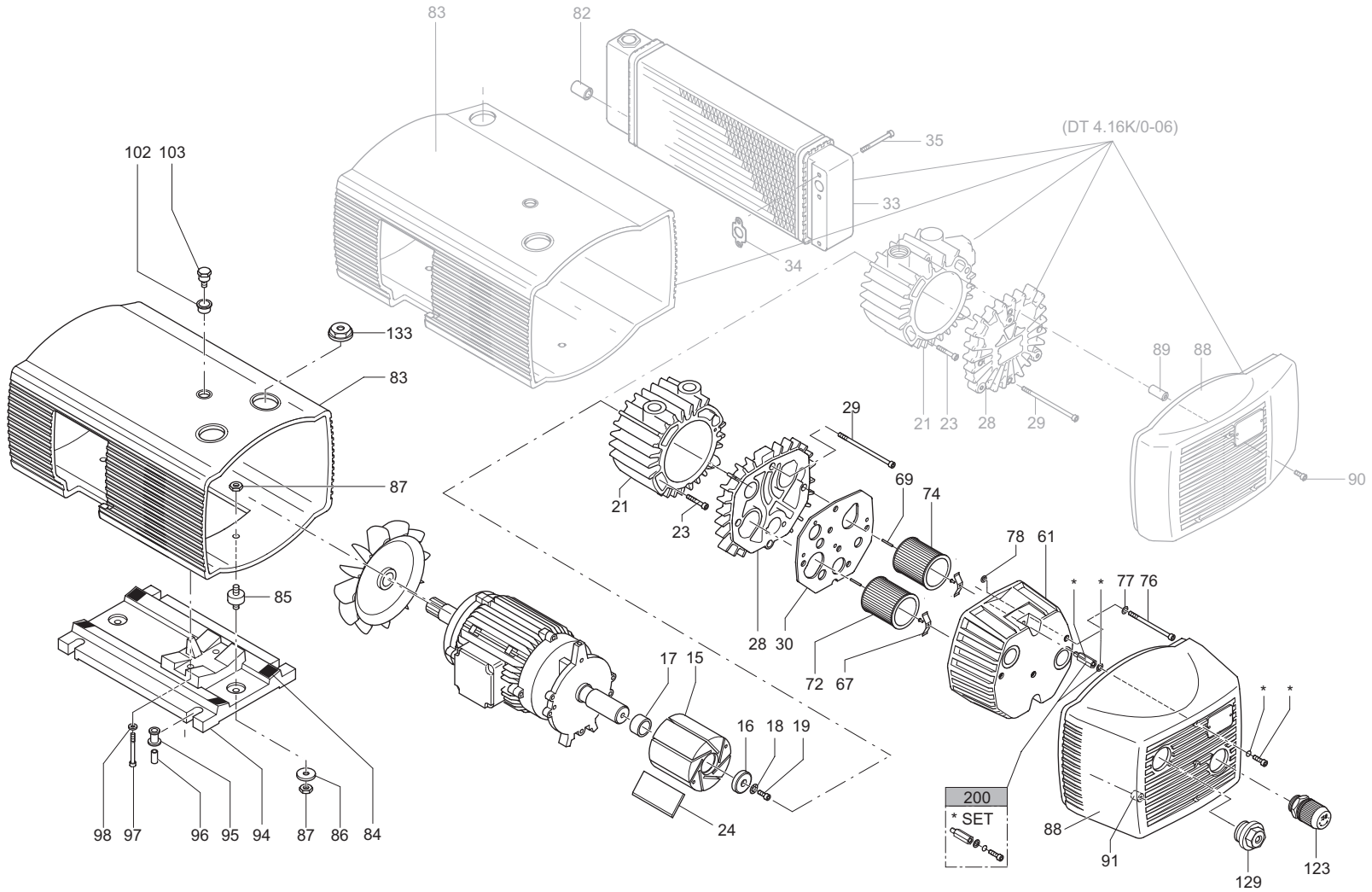

SERVICE ?

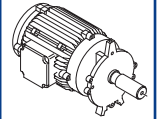
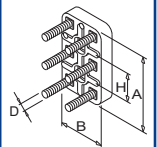
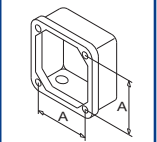
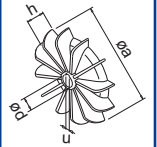
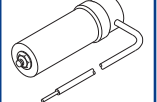

 C = ? μ F
 U = ? V

- INDEX	Pos.	Bestell Nr.	Beschreibung	
DT 4.10	15	020000 16200	KOLBEN	
	16	016800 05000	SPANNSCHEIBE	
	17	911001 00000	STAR-TOLERANZRING	
	18	949203 00000	ZAHNSCHEIBE	
	19	945320 00000	INNENSECHSKANTSCHRAUBE	
	21	000100 16200	GEHÄUSE	
	23	945319 00000	INNENSECHSKANTSCHRAUBE	
	24	901327 00007	SCHIEBER-KOHL E (SATZ)	
	28	000700 16200	SEITENDECKEL	
	29	945364 00000	INNENSECHSKANTSCHRAUBE	
	30	008901 16200	DICHTUNG	
	61	004800 27300	FILTERDECKEL	
	67	009000 16300	ANPRESSFEDER	
	69	952009 00000	SPANNHÜLSE	
	72	909518 00000	FILTERPATRONE (1x) ¹⁾	
	74	909554 00000	FILTERPATRONE (1x) ¹⁾	
	76	945364 00000	INNENSECHSKANTSCHRAUBE	
	77	948021 00000	DICHTRING	
	78	913161 00000	O-RING	
	83	006800 27300	GERÄTEHAUBE	
84	060901 16300	DÄMPFUNGSSTREIFEN		
85	741310 50000	GUMMIPUFFER		
86	949402 00000	UNTERLEGSCHLEIBE		
87	947001 00000	SECHSKANTMUTTER		
88	006801 27300	FRONTHAUBE		
91	951922 00000	GUMMIFORMTEIL		
94	015100 27300	MOTORFUSS		
95	951921 00000	GUMMIFORMTEIL		
96	068000 27600	DISTANZSTÜCK		
97	945363 00000	INNENSECHSKANTSCHRAUBE		
98	949451 00000	UNTERLEGSCHLEIBE		
102	968104 00000	GUMMI-DISTANZSTÜCK		
103	029600 16300	BOLZEN		
123	728003 99611	DRUCKREGULIERVENTIL		
129	943131 00000	DÜSE		
133	951224 00000	VERSCHLUSS-SCHRAUBE		
200	568000 27300	FRONTHAUBENBEFESTIGUNG (SATZ)		

¹⁾ erforderliche Bestellmenge / Wartung

- INDEX	Pos.	Bestell Nr.	Beschreibung	
DT 4.16	15	020000 16300	KOLBEN	
	16	016800 16300	SPANNSCHEIBE	
	17	911009 00000	STAR-TOLERANZRING	
	18	949203 00000	ZAHNSCHEIBE	
	19	945320 00000	INNENSECHSKANTSCHRAUBE	
	21	000105 16300	GEHÄUSE	
	23	945321 00000	INNENSECHSKANTSCHRAUBE	
	24	901347 00007	SCHIEBER-KOHL E (SATZ)	
	28	000705 16300	SEITENDECKEL	
	29	945372 00000	INNENSECHSKANTSCHRAUBE	
	30	008901 16300	DICHTUNG	
	61	004800 27400	FILTERDECKEL	
	67	009000 16300	ANPRESSFEDER	
	69	952009 00000	SPANNHÜLSE	
	72	909519 00000	FILTERPATRONE (1x) ¹⁾	
	74	909542 00000	FILTERPATRONE (1x) ¹⁾	
	76	945325 00000	INNENSECHSKANTSCHRAUBE	
	77	948021 00000	DICHTRING	
	78	913161 00000	O-RING	
	83	006800 27400	GERÄTEHAUBE	
84	060901 16300	DÄMPFUNGSSTREIFEN		
85	741310 50000	GUMMIPUFFER		
86	949402 00000	UNTERLEGSCHLEIBE		
87	947001 00000	SECHSKANTMUTTER		
88	006801 27400	FRONTHAUBE		
91	951922 00000	GUMMIFORMTEIL		
94	015100 27400	MOTORFUSS		
95	951921 00000	GUMMIFORMTEIL		
96	068000 27600	DISTANZSTÜCK		
97	945323 00000	INNENSECHSKANTSCHRAUBE		
98	949451 00000	UNTERLEGSCHLEIBE		
102	968104 00000	GUMMI-DISTANZSTÜCK		
103	029600 16300	BOLZEN		
123	728003 99611	DRUCKREGULIERVENTIL		
129	943131 00000	DÜSE		
133	951224 00000	VERSCHLUSS-SCHRAUBE		
200	568000 27300	FRONTHAUBENBEFESTIGUNG (SATZ)		

¹⁾ erforderliche Bestellmenge / Wartung

I INDEX	Pos.	Ident No.	Description	
DT 4.10	15	020000 16200	ROTOR	
	16	016800 05000	CLAMPING DISC	
	17	911001 00000	STAR-TOLERANCE-RING	
	18	949203 00000	TOOTHED SPRING WASHER	
	19	945320 00000	SOCKET HEAD SCREW	
	21	000100 16200	PUMP BODY	
	23	945319 00000	SOCKET HEAD SCREW	
	24	901327 00007	CARBON VANES (KIT)	
	28	000700 16200	LID	
	29	945364 00000	SOCKET HEAD SCREW	
	30	008901 16200	GASKET	
	61	004800 27300	FILTER COVER	
	67	009000 16300	BLADE SPRING	
	69	952009 00000	LOCATING PIN	
	72	909518 00000	FILTER CARTRIDGE (1x)¹⁾	
	74	909554 00000	FILTER CARTRIDGE (1x)¹⁾	
	76	945364 00000	SOCKET HEAD SCREW	
	77	948021 00000	SEALING RING	
	78	913161 00000	O-RING	
	83	006800 27300	PROTECTIVE HOOD	
84	060901 16300	ELASTIC PAD		
85	741310 50000	RUBBER BUFFER		
86	949402 00000	WASHER		
87	947001 00000	HEX.NUT		
88	006801 27300	FRONT HOOD		
91	951922 00000	RUBBER ELEMENT		
94	015100 27300	FOOT		
95	951921 00000	RUBBER ELEMENT		
96	068000 27600	SPACING COLLAR		
97	945363 00000	SOCKET HEAD SCREW		
98	949451 00000	WASHER		
102	968104 00000	RUBBER SLEEVE		
103	029600 16300	BOLT		
123	728003 99611	PRESSURE REGULATING VALVE		
129	943131 00000	NOZZLE		
133	951224 00000	SCREW PLUG		
200	568000 27300	FRONT HOOD ATTACHMENT (KIT)		

¹⁾ necessary order quantity / maintenance

I INDEX	Pos.	Ident No.	Description	
DT 4.16	15	020000 16300	ROTOR	
	16	016800 16300	CLAMPING DISC	
	17	911009 00000	STAR-TOLERANCE-RING	
	18	949203 00000	TOOTHED SPRING WASHER	
	19	945320 00000	SOCKET HEAD SCREW	
	21	000105 16300	PUMP BODY	
	23	945321 00000	SOCKET HEAD SCREW	
	24	901347 00007	CARBON VANES (KIT)	
	28	000705 16300	LID	
	29	945372 00000	SOCKET HEAD SCREW	
	30	008901 16300	GASKET	
	61	004800 27400	FILTER COVER	
	67	009000 16300	BLADE SPRING	
	69	952009 00000	LOCATING PIN	
	72	909519 00000	FILTER CARTRIDGE (1x)¹⁾	
	74	909542 00000	FILTER CARTRIDGE (1x)¹⁾	
	76	945325 00000	SOCKET HEAD SCREW	
	77	948021 00000	SEALING RING	
	78	913161 00000	O-RING	
	83	006800 27400	PROTECTIVE HOOD	
84	060901 16300	ELASTIC PAD		
85	741310 50000	RUBBER BUFFER		
86	949402 00000	WASHER		
87	947001 00000	HEX.NUT		
88	006801 27400	FRONT HOOD		
91	951922 00000	RUBBER ELEMENT		
94	015100 27400	FOOT		
95	951921 00000	RUBBER ELEMENT		
96	068000 27600	SPACING COLLAR		
97	945323 00000	SOCKET HEAD SCREW		
98	949451 00000	WASHER		
102	968104 00000	RUBBER SLEEVE		
103	029600 16300	BOLT		
123	728003 99611	PRESSURE REGULATING VALVE		
129	943131 00000	NOZZLE		
133	951224 00000	SCREW PLUG		
200	568000 27300	FRONT HOOD ATTACHMENT (KIT)		

¹⁾ necessary order quantity / maintenance

I INDICE	Pos.	No. Identification	Designation	FR	
DT 4.10	15	020000 16200	PISTON		
	16	016800 05000	DISQUE DE SERRAGE		
	17	911001 00000	BAGUE STAR		
	18	949203 00000	DENT DISQUE		
	19	945320 00000	VIS HEXAGONALE INTERNE		
	21	000100 16200	CORP DE POMPE		
	23	945319 00000	VIS HEXAGONALE INTERNE		
	24	901327 00007	PALETTE DE CHARBON (KIT)		
	28	000700 16200	COUVERCLE		
	29	945364 00000	VIS HEXAGONALE INTERNE		
	30	008901 16200	JOINT		
	61	004800 27300	COUVERCLE DU FILTRE		
	67	009000 16300	RESSORT-JAME		
	69	952009 00000	DOVILLE DE ETRAGE		
	72	909518 00000	CARTOUCHE FILTRANTE (1x)¹⁾		
	74	909554 00000	CARTOUCHE FILTRANTE (1x)¹⁾		
	76	945364 00000	VIS HEXAGONALE INTERNE		
	77	948021 00000	JOINT		
	78	913161 00000	ANNEAU-O		
	83	006800 27300	CAPOT DE PROTECTION		
84	060901 16300	AMORTISSEUR			
85	741310 50000	AMORTISSEUR EN CAOUTCHOUC			
86	949402 00000	RONDELLE			
87	947001 00000	ECROU A 6PANS			
88	006801 27300	CAPOT AVANT			
91	951922 00000	ELEMENT EN CAOUTCHOUC			
94	015100 27300	PIED			
95	951921 00000	ELEMENT EN CAOUTCHOUC			
96	068000 27600	DONILLE D'ECARMENT			
97	945363 00000	VIS HEXAGONALE INTERNE			
98	949451 00000	RONDELLE			
102	968104 00000	PIECE D'ECARTEMENT CAOUTCHOUC			
103	029600 16300	BOULON			
123	728003 99611	SOUPAPE REGLAGE PRESSION			
129	943131 00000	AJUTAGE			
133	951224 00000	BOUCHON			
200	568000 27300	PIÈCES DE FIXATION DU CAPOT AVANT (KIT)			

¹⁾ quantité nécessaire / entretien

I INDICE	Pos.	No. Identification	Designation	FR	
DT 4.16	15	020000 16300	PISTON		
	16	016800 16300	DISQUE DE SERRAGE		
	17	911009 00000	BAGUE STAR		
	18	949203 00000	DENT DISQUE		
	19	945320 00000	VIS HEXAGONALE INTERNE		
	21	000105 16300	CORP DE POMPE		
	23	945321 00000	VIS HEXAGONALE INTERNE		
	24	901347 00007	PALETTE DE CHARBON (KIT)		
	28	000705 16300	COUVERCLE		
	29	945372 00000	VIS HEXAGONALE INTERNE		
	30	008901 16300	JOINT		
	61	004800 27400	COUVERCLE DU FILTRE		
	67	009000 16300	RESSORT-JAME		
	69	952009 00000	DOVILLE DE ETRAGE		
	72	909519 00000	CARTOUCHE FILTRANTE (1x)¹⁾		
	74	909542 00000	CARTOUCHE FILTRANTE (1x)¹⁾		
	76	945325 00000	VIS HEXAGONALE INTERNE		
	77	948021 00000	JOINT		
	78	913161 00000	ANNEAU-O		
	83	006800 27400	CAPOT DE PROTECTION		
84	060901 16300	AMORTISSEUR			
85	741310 50000	AMORTISSEUR EN CAOUTCHOUC			
86	949402 00000	RONDELLE			
87	947001 00000	ECROU A 6PANS			
88	006801 27400	CAPOT AVANT			
91	951922 00000	ELEMENT EN CAOUTCHOUC			
94	015100 27400	PIED			
95	951921 00000	ELEMENT EN CAOUTCHOUC			
96	068000 27600	DONILLE D'ECARMENT			
97	945323 00000	VIS HEXAGONALE INTERNE			
98	949451 00000	RONDELLE			
102	968104 00000	PIECE D'ECARTEMENT CAOUTCHOUC			
103	029600 16300	BOULON			
123	728003 99611	SOUPAPE REGLAGE PRESSION			
129	943131 00000	AJUTAGE			
133	951224 00000	BOUCHON			
200	568000 27300	PIÈCES DE FIXATION DU CAPOT AVANT (KIT)			

¹⁾ quantité nécessaire / entretien

I INDICE	Pos.	No. Identificazione	Designazione
DT 4.10	15	020000 16200	ROTORE
	16	016800 05000	DISCO DI FISSAGGIO
	17	911001 00000	STAR-ANELLO TOLLERANZA
	18	949203 00000	DISCO A DENTE
	19	945320 00000	VITE ESAGONALE INTERNA
	21	000100 16200	CARCASSA
	23	945319 00000	VITE ESAGONALE INTERNA
	24	901327 00007	PALETTE DI CHARBONE (KIT)
	28	000700 16200	COPERCHIO
	29	945364 00000	VITE ESAGONALE INTERNA
	30	008901 16200	GUARNIZIONE
	61	004800 27300	COPERCHIO FILTRO
	67	009000 16300	MOLLA
	69	952009 00000	SPINE DI RISCONTRO
	72	909518 00000	CARTUCCIA FILTRO (1x)¹⁾
	74	909554 00000	CARTUCCIA FILTRO (1x)¹⁾
	76	945364 00000	VITE ESAGONALE INTERNA
	77	948021 00000	ANELLO GUARNIZIONE
	78	913161 00000	ANELLO-O
	83	006800 27300	COPERCHIO DI PROTEZIONE
84	060901 16300	AMORTIZZATORE	
85	741310 50000	AMMORTIZZATORE IN GOMMA	
86	949402 00000	RONDELLA	
87	947001 00000	DADO ESAGONALE	
88	006801 27300	COFANO	
91	951922 00000	ELEMENTO IN GOMMA	
94	015100 27300	PIEDE	
95	951921 00000	ELEMENTO IN GOMMA	
96	068000 27600	BOCCOLA DISTANZIATRICE	
97	945363 00000	VITE ESAGONALE INTERNA	
98	949451 00000	RONDELLA	
102	968104 00000	PEZZO DI SCOSTAM. IN GOMMA	
103	029600 16300	BULLONE	
123	728003 99611	VALVOLA REGOLAZIONE PRESSIONE	
129	943131 00000	UGELLO	
133	951224 00000	VITE DI CHIUSURA	
200	568000 27300	PARTI DI FISSAGGIO DEL COFANO (KIT)	

¹⁾ quantità di ordinazione necessari / manutenzione

I INDICE	Pos.	No. Identificazione	Designazione
DT 4.16	15	020000 16300	ROTORE
	16	016800 16300	DISCO DI FISSAGGIO
	17	911009 00000	STAR-ANELLO TOLLERANZA
	18	949203 00000	DISCO A DENTE
	19	945320 00000	VITE ESAGONALE INTERNA
	21	000105 16300	CARCASSA
	23	945321 00000	VITE ESAGONALE INTERNA
	24	901347 00007	PALETTE DI CHARBONE (KIT)
	28	000705 16300	COPERCHIO
	29	945372 00000	VITE ESAGONALE INTERNA
	30	008901 16300	GUARNIZIONE
	61	004800 27400	COPERCHIO FILTRO
	67	009000 16300	MOLLA
	69	952009 00000	SPINE DI RISCONTRO
	72	909519 00000	CARTUCCIA FILTRO (1x)¹⁾
	74	909542 00000	CARTUCCIA FILTRO (1x)¹⁾
	76	945325 00000	VITE ESAGONALE INTERNA
	77	948021 00000	ANELLO GUARNIZIONE
	78	913161 00000	ANELLO-O
	83	006800 27400	COPERCHIO DI PROTEZIONE
84	060901 16300	AMORTIZZATORE	
85	741310 50000	AMMORTIZZATORE IN GOMMA	
86	949402 00000	RONDELLA	
87	947001 00000	DADO ESAGONALE	
88	006801 27400	COFANO	
91	951922 00000	ELEMENTO IN GOMMA	
94	015100 27400	PIEDE	
95	951921 00000	ELEMENTO IN GOMMA	
96	068000 27600	BOCCOLA DISTANZIATRICE	
97	945323 00000	VITE ESAGONALE INTERNA	
98	949451 00000	RONDELLA	
102	968104 00000	PEZZO DI SCOSTAM. IN GOMMA	
103	029600 16300	BULLONE	
123	728003 99611	VALVOLA REGOLAZIONE PRESSIONE	
129	943131 00000	UGELLO	
133	951224 00000	VITE DI CHIUSURA	
200	568000 27300	PARTI DI FISSAGGIO DEL COFANO (KIT)	







¹⁾ quantità di ordinazione necessari / manutenzione

I ÍNDICE	Pos.	No. De pedido	Descripción	
DT 4.10	15	020000 16200	ÉMBOLO	
	16	016800 05000	ARANDELA TENSORA	
	17	911001 00000	ANILLO DE TOLERANCIA STAR	
	18	949203 00000	POLEA DENTADA	
	19	945320 00000	TORNILLO HEXAGONAL INTERIOR	
	21	000100 16200	CARCASA	
	23	945319 00000	TORNILLO HEXAGONAL INTERIOR	
	24	901327 00007	EMPUJADOR DE CARBÓN (KIT)	
	28	000700 16200	TAPA LATERAL	
	29	945364 00000	TORNILLO HEXAGONAL INTERIOR	
	30	008901 16200	JUNTA	
	61	004800 27300	TAPA DE FILTRO	
	67	009000 16300	MUELLE DE PRESIÓN	
	69	952009 00000	CASQUILLO TENSOR	
	72	909518 00000	CARTUCHO DE FILTRO (1x)¹⁾	
	74	909554 00000	CARTUCHO DE FILTRO (1x)¹⁾	
	76	945364 00000	TORNILLO HEXAGONAL INTERIOR	
	77	948021 00000	ANILLO DE JUNTA	
	78	913161 00000	JUNTA TÓRICA	
	83	006800 27300	CUBIERTA DEL APARATO	
84	060901 16300	TIRAS DE AMORTIGUACIÓN		
85	741310 50000	AMORTIGUADOR DE GOMA		
86	949402 00000	ARANDELA		
87	947001 00000	TUERCA HEXAGONAL		
88	006801 27300	CUBIERTA FRONTAL		
91	951922 00000	PIEZA DE ORMA DE GOMA		
94	015100 27300	PIE DE MOTOR		
95	951921 00000	PIEZA DE ORMA DE GOMA		
96	068000 27600	PIEZA DISTANCIADORA		
97	945363 00000	TORNILLO HEXAGONAL INTERIOR		
98	949451 00000	ARANDELA		
102	968104 00000	PIEZA DE GOMA DISTANCIADORA		
103	029600 16300	BULÓN		
123	728003 99611	VÁLVULA REGULADORA DE PRESIÓN		
129	943131 00000	TOBERA		
133	951224 00000	TORNILLO DE CIERRE		
200	568000 27300	PIEZAS DE FIJACIÓN DE LA CUBIERTA FRONTAL (KIT)		







¹⁾ cantidad necesario / mantenimiento

I ÍNDICE	Pos.	No. De pedido	Descripción	
DT 4.16	15	020000 16300	ÉMBOLO	
	16	016800 16300	ARANDELA TENSORA	
	17	911009 00000	ANILLO DE TOLERANCIA STAR	
	18	949203 00000	POLEA DENTADA	
	19	945320 00000	TORNILLO HEXAGONAL INTERIOR	
	21	000105 16300	CARCASA	
	23	945321 00000	TORNILLO HEXAGONAL INTERIOR	
	24	901347 00007	EMPUJADOR DE CARBÓN (KIT)	
	28	000705 16300	TAPA LATERAL	
	29	945372 00000	TORNILLO HEXAGONAL INTERIOR	
	30	008901 16300	JUNTA	
	61	004800 27400	TAPA DE FILTRO	
	67	009000 16300	MUELLE DE PRESIÓN	
	69	952009 00000	CASQUILLO TENSOR	
	72	909519 00000	CARTUCHO DE FILTRO (1x)¹⁾	
	74	909542 00000	CARTUCHO DE FILTRO (1x)¹⁾	
	76	945325 00000	TORNILLO HEXAGONAL INTERIOR	
	77	948021 00000	ANILLO DE JUNTA	
	78	913161 00000	JUNTA TÓRICA	
	83	006800 27400	CUBIERTA DEL APARATO	
84	060901 16300	TIRAS DE AMORTIGUACIÓN		
85	741310 50000	AMORTIGUADOR DE GOMA		
86	949402 00000	ARANDELA		
87	947001 00000	TUERCA HEXAGONAL		
88	006801 27400	CUBIERTA FRONTAL		
91	951922 00000	PIEZA DE ORMA DE GOMA		
94	015100 27400	PIE DE MOTOR		
95	951921 00000	PIEZA DE ORMA DE GOMA		
96	068000 27600	PIEZA DISTANCIADORA		
97	945323 00000	TORNILLO HEXAGONAL INTERIOR		
98	949451 00000	ARANDELA		
102	968104 00000	PIEZA DE GOMA DISTANCIADORA		
103	029600 16300	BULÓN		
123	728003 99611	VÁLVULA REGULADORA DE PRESIÓN		
129	943131 00000	TOBERA		
133	951224 00000	TORNILLO DE CIERRE		
200	568000 27300	PIEZAS DE FIJACIÓN DE LA CUBIERTA FRONTAL (KIT)		

¹⁾ cantidad necesario / mantenimiento

DT 4.10/XX DT 4.16/XX	Variante 	Pos. ²⁾	Bestell Nr. / Ident No. / No. Identification / No. Identificazione / No. De pedido		Beschreibung / Description / Designation / Designazione / Desripcion
			  	  	
DT 4.10					
① 1~ Einphasenwechselstrom 1~ single-phase AC 1~ AC monophasé 1~ AC monofase 1~ AC monofásica		5	964233 00000		WINKEL / BRACKET / SUPPORT / SUPPORTO / SOPORTE
		6	945204 00000		SECHSKANTSCHRAUBE / HEX-HEAD SCREW / VIS HEXAGONALE / VITE ESAGONALE / TORNILLO DE CABEZA HEXAGONAL
		7	947102 00000		MUTTER / NUT / ECROU / DADO / TUERCA
		8	742002 40000		KABEL / CABLE / CABLE / CAVO / CABLE
		83	006802 27300	006800-27300	HAUBE / PROTECTING HOOD / CARTER PROTECTEUR / CARTER DI PROTEZIONE / CAPERUZA
DT 4.16					
② 1~ Einphasenwechselstrom 1~ single-phase AC 1~ AC monophasé 1~ AC monofase 1~ AC monofásica		5	964233 00000		WINKEL / BRACKET / SUPPORT / SUPPORTO / SOPORTE
		6	945204 00000		SECHSKANTSCHRAUBE / HEX-HEAD SCREW / VIS HEXAGONALE / VITE ESAGONALE / TORNILLO DE CABEZA HEXAGONAL
		7	947102 00000		MUTTER / NUT / ECROU / DADO / TUERCA
		8	742002 40000		KABEL / CABLE / CABLE / CAVO / CABLE
		83	006802 27400	006800-27400	HAUBE / PROTECTING HOOD / CARTER PROTECTEUR / CARTER DI PROTEZIONE / CAPERUZA
③+④ /05-51		24	901375 00007	901347-00007	SATZ (KIT) SCHIEBER / VANES / PALETTE / PALETTE / EMBUJADOR
		30	008902 16300	008901-16300	DICHTUNG / GASKET / JOINT / GUARNIZIONI / ANILLO
		31	903243 00000		DICHTUNG / GASKET / JOINT / GUARNIZIONI / ANILLO
		74		909542-00000	FILTERPATRONE / FILTER CARTRIDGE / CARTOUCHE FILTRANTE / CARTUCCIA FILTRO / CARTUCHO DE FILTRO
		95		951921-00000	GUMMIFORMTEIL / RUBBER ELEMENT / ELEMENT EN CAOUTCHOUC / ELEMENTO IN GOMMA / PIEZA DE ORMA DE GOMA
		96		068000-27600	DISTANZSTÜCK / SPACING COLLAR / DONILLE D'ECARMENT / BOCCOLA DISTANZIATRICE / PIEZA DISTANCIADORA
		129		943131-00000	DÜSE / NOZZLE / AJUTAGE / UGELLO / TOBERA
		133		951224-00000	VERSCHLUSS-SCHRAUBE / SCREW PLUG / BOUCHON / VITE DI CHIUSURA / TORNILLO DE CIERRE

²⁾ variantenabhängige Bauteile / variant-dependent components / composants variante-dependantes / componenti variante-dispendenti / componentes variante-dependientes

DT 4.10/XX DT 4.16/XX	Variante 	Pos. ²⁾	Bestell Nr. / Ident No. / No. Identification / No. Identificazione / No. De pedido		Beschreibung / Description / Designation / Designazione / Desripcion
			  	  	
DT 4.16					
⑤ K/0-06 3~ mit Kühler - ohne Filterung 3~ with cooler - without filter 3~ avec refroidisseur - sans filtre 3~ con raffreddatore - senza filtro 3~ con refrigerador - sin filtro					
		21	000101 27400	000105 16300	GEHÄUSE / PUMP BODY / CORP DE POMPE / CARCASSA / CARCASA
		28	000700 27400	000705 16300	SEITENDECKEL / LID / COUVERCLE / COPERCHIO / TAPA LATERAL
		30		008901 16300	DICHTUNG / GASKET / JOINT / GUARNIZIONI / ANILLO
		33	560200 27400		KÜHLER / COOLER / REFRROIDISSEUR / RAFFREDDATORE / REFRIGERADOR
		34	005700 27600		DICHTUNG / GASKET / JOINT / GUARNIZIONI / ANILLO
		35	945324 00000		INNENSECHSKANTSCHRAUBE / SOCKET HEAD SCREW / VIS HEXAGONALE INTERNE / VITE ESAGONALE INTERNA / TORNILLO HEXAGONAL INTERIOR
		61		004800 27400	FILTERDECKEL / FILTER COVER / COUVERCLE DU FILTRE / COPERCHIO FILTRO / TAPA DE FILTRO
		67		009000 16300	ANPRESSFEDER / LEAF SPRING / RESSORT-JAME / MOLLA / MUELLE DE PRESIÓN
		69		952009 00000	SPANNHÜLSE / LOCATING PEG / DOVILLE DE ETRAGE / SPINE DI RISCOントRO / CASQUILLO TENSOR
		72		909519 00000	FILTERPATRONE / FILTER CARTRIDGE / CARTOUCHE FILTRANTE / CARTUCCIA FILTRO / CARTUCHO DE FILTRO
		74		909542 00000	FILTERPATRONE / FILTER CARTRIDGE / CARTOUCHE FILTRANTE / CARTUCCIA FILTRO / CARTUCHO DE FILTRO
		76		945325 00000	INNENSECHSKANTSCHRAUBE / SOCKET HEAD SCREW / VIS HEXAGONALE INTERNE / VITE ESAGONALE INTERNA / TORNILLO HEXAGONAL INTERIOR
		77		948021 00000	DICHTUNG / GASKET / JOINT / GUARNIZIONI / ANILLO
		78		913161 00000	DICHTUNG / GASKET / JOINT / GUARNIZIONI / ANILLO
		82	742609 02000		SCHLAUCHSTÜCK / FLEXIBLE HOSE / TUYAU FLEXIBLE / TUBO FLESSIBILE / MANGUERA
		83	006806 27400	006802 27400	(1~) HAUBE / PROTECTING HOOD / CARTER PROTECTEUR / CARTER DI PROTEZIONE / CAPERUZA
		83	006803 27400	006800 27400	(3~) HAUBE / PROTECTING HOOD / CARTER PROTECTEUR / CARTER DI PROTEZIONE / CAPERUZA
		88	006804 27400	006801 27400	HAUBE / PROTECTING HOOD / CARTER PROTECTEUR / CARTER DI PROTEZIONE / CAPERUZA
		89	741310 90000	068000 27300	GUMMIPUFFER / RUBBER BUFFER / AMORTISSEUR EN CAOUTCHOUC / AMMORTIZZATORE IN GOMMA / AMORTIGUADOR DE GOMA
		90	945377 00000	945320 00000	INNENSECHSKANTSCHRAUBE / SOCKET HEAD SCREW / VIS HEXAGONALE INTERNE / VITE ESAGONALE INTERNA / TORNILLO HEXAGONAL INTERIOR
		91		951922 00000	GUMMIPUFFEER / RUBBER ELEMENT / ELEMENT EN CAOUTCHOUC / ELEMENTO IN GOMMA / PIEZA DE ORMA DE GOMA
		111		913161 00000	O-RING / O-RING / ANNEAU-O / ANELLO-O / JUNTA TÓRICA
		112		741300 27600	GUMMISCHEIBE / RUBBER DISC / RONDELLE DE CAOUTCHOUC / RONDELLA IN GOMMA / ARANDELA DE GOMA
		123		72800 399611	DRUCKREGULIERVENTIL / PRESSURE REGULATING VALVE / SOUPAPE REGLAGE PRESSION / VALVOLA REGOLAZIONE PRESSIONE / VÁLVULA REGULADORA DE PRESIÓN
		129		943131 00000	DÜSE / NOZZLE / AJUTAGE / UGELLO / TOBERA
		133		951224 00000	VERSCHLUSS-SCHRAUBE / SCREW PLUG / BOUCHON / VITE DI CHIUSURA / TORNILLO DE CIERRE

²⁾ variantenabhängige Bauteile / variant-dependent components / composants variante-dependantes / componenti variante-dispendenti / componentes variante-dependientes